

Conditions for using, storing and transporting Festo products

What must be taken into account when using Festo products?

The limit values specified in the technical data and any specific safety instructions must be adhered to by the user in order to ensure correct functioning.

The pneumatic components must be supplied with correctly prepared compressed air free of aggressive media → page 5 onwards.

Take the ambient conditions at the place of use into consideration. Corrosive, abrasive and dusty environments (e.g. water, ozone, grinding dust) will reduce the service life of the product.

Check the resistance of the materials of Festo products to the media used and surrounding media → page 23.

When Festo products are used in safety-oriented applications, all national and international laws and regulations, for example the Machinery Directive, together with the relevant references to standards, trade association rules and the applicable international regulations must be observed and complied with.

Unauthorised conversions or modifications to products and systems from Festo constitute a safety risk and are thus not permitted.

Festo doesn't accept any liability for any resulting damage.

You should consult Festo if one of the following applies to your application:

- The ambient conditions and operating conditions or the operating medium differ from the specified technical data.
- The product is to perform a safety function.
- A risk or safety analysis is required.
- You are unsure about the product's suitability for the planned application.

- You are unsure about the product's suitability for use in safety-oriented applications.

All technical data is correct at the time of going to print.

All content, texts, illustrations, images and drawings included in this document are the intellectual property of Festo SE & Co. KG and are protected by copyright law.

Any duplication, processing, translation, microfilming, storage, or processing in electronic systems of any kind whatsoever without the consent of Festo SE & Co. KG is prohibited.

All technical data is subject to change according to technical advances.

Storage conditions

Temperature

The temperature range in storage areas must be between 10°C and 40°C all year round. Rapid changes of temperature in the storage area should be avoided. Heat sources such as heating elements, heating pipes and the like should be shielded to ensure the stored goods are not directly subject to radiant heat.

UV radiation

No direct sunlight (skylights, vent flaps, etc.) and no high-UV artificial lighting. Use fluorescent tubes with UV protection.

Ambient air

Air circulation and a permanent (proportional) feed of ambient air to the storage room is absolutely essential. You must prevent any media that may affect the materials, e.g. solvents and the like arising from production processes, from entering the storage areas. The storage location should not contain any equipment that generates ozone such as indoor air ionisers or high-voltage equipment.

The relative humidity should not exceed 75%. Condensation must be avoided in all cases.

Dust

The parts must be stored in suitable containers. The storage room must as far as possible be free of dust. Attention should be paid in particular to using abrasion-resistant, non-porous floor coverings, and ingress of dust particles from external sources (ambient air) should be prevented.

When repairs are being made to the building technology systems in the warehouse (welding, grinding etc.), the stored goods should be protected from welding spatter, chips etc.

Adding to/removing from storage

The parts should not be exposed to any extreme fluctuations in temperature.

Mechanical effect

All products, including packs of spare parts/wearing parts for example, should be stored in such a way that they are not mechanically deformed or damaged, i.e. no buckling or sagging, no point loads. Direct contact between elastomer products and copper or manganese for an extended period should also be avoided because of possible reciprocal effects.

Stock management

To avoid storing parts for long periods of time, the first-in first-out principle should be followed. The total storage period should be kept as short as possible. In principle, the specified guarantee periods apply.

Transport conditions

In principle, there are no restrictions in terms of ambient conditions during land/sea or air transport, provided the products are sufficiently protected in accordance with the specifications in the product datasheet by using appropriate product and shipping packaging. If necessary, special transport such as temper-

ature-controlled transport can be organised. However, this should be agreed contractually and as a separate financial matter.

Standards in pneumatics – Warning symbols to IEC 60417

Standards in pneumatics

Standards are also of great importance in pneumatics. Standards mean harmonisation (standardisation). Standardisation is also the basis for the free trade of goods and services between companies nationally as well as internationally. Standards in industry describe the latest state of technology. They provide a common basis for the evaluation of technical aspects. Standards relevant for pneu-

matics deal with dimensions, safety and quality. Festo has for many years been actively working with the relevant national and international standards organisations.

Pneumatic drives

- Standards-based cylinders to ISO 6432
- Standards-based cylinders to ISO 21287.
- Standards-based cylinders to ISO 15552 (ISO 6431, DIN ISO 6431, VDMA 24562), NFE 49003.1 and UNI 10290.
- Rod clevises to ISO 8140 and DIN 71752
- Rod eyes to ISO 12240-4, dimension series K

Valves or valve terminals

- Valve terminals for standard valves
- Solenoid and pneumatic valves with port pattern to ISO 15407-1.
- Valve sub-bases to ISO 15407-1.
- Valve terminals with port pattern to ISO 15407-2.
- Solenoid and pneumatic valves with port pattern to ISO 5599-1.
- Valve terminals with port pattern to DIN ISO 5599-2.
- Valve sub-bases with port pattern to ISO 5599-1 and external dimensions to VDMA 24345.
- Solenoid valves with port pattern to VDI/VDE 3845 (NAMUR).

Compressed air preparation

- Compressed air quality to ISO 8573-1:2010
- Bourdon tube pressure gauges to EN 837-1
- Capsule pressure gauges to EN 837-3
- Air reservoirs to directive 2014/68/EU, 2014/29/EU or EN 286-1.

Warning symbols to IEC 60417

Warning symbols are displayed on certain products and packaging from Festo. These symbols identify products that require specialist expertise to install. These products must be installed by a professional, as installation is associated with risks.

IEC 60417-6182: Installation, electrotechnical expertise

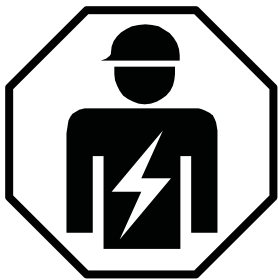

To identify electrotechnical equipment and products. The installation of the product marked in this way requires particular electrotechnical expertise.

IEC 60417-6183: Installation, mechanical expertise



To identify mechanical equipment and products. The installation of the product marked in this way requires particular mechanical expertise.

Pressure media

Pressure media for operating pneumatic components from Festo

Compressed air, nitrogen in a gaseous state and noble gases in a gaseous state can be used as pressure medium for operating pneumatic components from Festo.

Please note the following when preparing the pressure media.

Nitrogen (N):

Ambient air comprises approx. 78% nitrogen and 21% oxygen. Nitrogen is an inert gas and does not react under normal conditions.

Provided the following parameters are adhered to, our products can be operated with pure nitrogen (100%) as the pressure medium without any restriction to their service life.

- The nitrogen used must be in a gaseous state
- The operating pressure, operating temperatures and quality (particles, humidity, oil content) must comply with the values specified for compressed air in the datasheet
- Flow sensors are calibrated using the operating medium specified in the datasheet only; operation with other gases will give incorrect results.

Noble gases (helium (He), neon (Ne), argon (Ar), krypton (Kr), xenon (Xe):

Noble gases are inert and can therefore be used as operating media. Helium, as the lightest of the noble gases, is highly capable of permeating into polymers and elastomers, which can cause gas losses when operating pneumatic components.

Provided the following parameters are adhered to, our products can be operated with noble gases as the pressure medium without any restriction to their service life.

- The noble gases used must be in the gaseous state
- The operating pressure, operating temperatures and quality (particles, humidity, oil content) must comply with the values specified for compressed air in the datasheet
- Flow sensors are calibrated using the operating medium specified in the datasheet only; operation with other gases will give incorrect results

Carbon dioxide (CO₂):

Carbon dioxide CO₂ is a colourless, non-flammable gas, which dissolves easily in water to form carbonic acid. It is widely used, e.g. as a drink additive in food technology or as a protective gas in technical applications.

Carbon dioxide can be used as an operating medium without restricting the service life of our products, provided the following parameters are met:

- The carbon dioxide must be in a gaseous state.
- The operating pressure, operating temperatures and quality (particles, humidity, oil content) must comply with the values specified for compressed air in the datasheet.
- Carbon dioxide must not be used as the operating medium for applications with an operating pressure > 20 bar.
- Flow sensors are calibrated using the operating medium specified in the datasheet only; operation with other gases will give incorrect results.

Attention

When using nitrogen, carbon dioxide or noble gases as operating medium, it is essential to ensure sufficient ventilation of the affected space (danger of suffocation if the operating medium escapes).

Pressure media

Water

Festo products are primarily designed for operation with compressed air. If water is specified as an alternative possible operating medium for Festo products, the materials that come into contact with the media are in principle compatible with water. This does not guarantee a particular longevity of the products. In comparison with air, however, water has certain properties that must be taken into account in permanent operation.

- Water has a corrosion-stimulating effect.
Particularly in the case of metal fittings, care must be taken to ensure that the material used for the fittings is electrochemically compatible with the material of the screw-in thread or sealing rings, if appropriate.
- Any leakage can have worse consequences in the case of water than with compressed air.
If Festo products are used in cooling or heating circuits, the increased thermal load can lead to more rapid wear or sticking of seals.
If there were a fault during permanent operation, escaping water should be considered from the point of view of secondary damage (e.g. emptying of cooling systems, damage to electrical/electronic components).
- Not all water is the same.
The term 'water' used here should be understood to mean liquid mains water that is free of ice. The suitability of the products for water modified in any way, such as demineralised water, salt water or water with additives, as well as water in the vapour phase, must be enquired about separately.
- The suitability of the products for water – provided nothing is stated to the contrary – should not be understood as approval for e.g. drinking water applications or underfloor heating.
- Water cannot be compressed.
In hydraulic systems, e.g. when switching valves, the lack of compressibility can lead to pressure peaks. These peaks must not exceed the pressure range approved for the product.

Compressed air preparation

Why compressed air preparation?

Properly prepared compressed air helps to prevent faults in pneumatic components. It increases the service life of the components and reduces machine failures and downtime, thereby increasing process reliability.

Compressed air contains contaminants in the form of

- particles,
- water and
- oil.

Water and oil can be in liquid or gaseous form and change from one state to another within the compressed air system.

None of these three contaminants are present in a compressed air system in their pure form; they will occur in a mixture. The composition of this mixture can vary greatly at different times in different places in the system. For example, water can collect in branch lines or particles can become deposited in empty spaces over time, and then be propelled along at one stroke by a pressure surge.

Poorly prepared compressed air causes faults such as:

- Fast seal wear
- Oiled-up valves in the control section

- Dirty silencers

Possible effects for the user and machine:

- Reduced machine availability
- Higher energy costs due to leaks
- Higher maintenance costs
- Shorter component and system service life

Particles

Particles in the compressed air usually occur in the form of dust (carbon black, abraded and corrosion particles). Metal chips (e.g. from conversion work) and residues of sealants such as PTFE tape can also occasionally get into the compressed air via the compressed air system.

The particles are classified as fine dust: size 0.1 ... 5 μm and coarse dust: size > 5 μm in accordance with ISO 8573-1:2010.

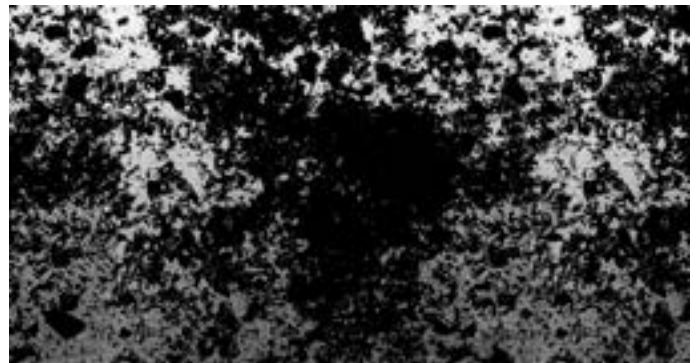

Water content in air S as a function of air temperature T

The maximum water content in air (100% relative air humidity) is dependent on temperature. Air can only absorb a certain amount of water (in g) per volumetric unit (in m^3), irrespective of pressure. The warmer the air, the more water it can absorb. Excessive humidity manifests itself as condensation. If the air temperature drops, for example from 20°C to 3°C, the maximum water content of the compressed air is reduced from 18 g/m^3 to 6 g/m^3 . The compressed air can therefore only absorb approx. 1/3 as much water as before. The rest (12 g/m^3) is precipitated as drops (dew) and must be drawn off so that it cannot cause any malfunctions.

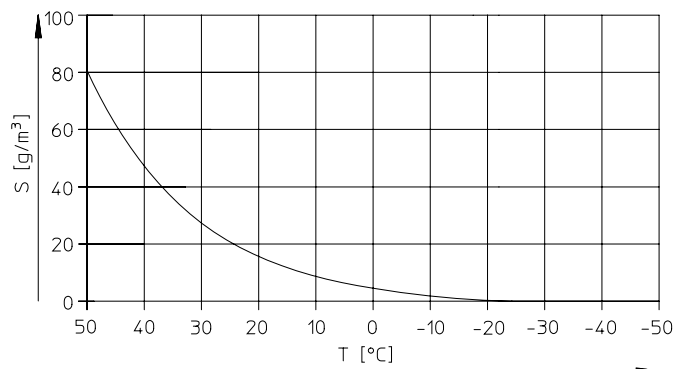

Water condensation

Water is always present in the air in the form of humidity. When compressed air is cooled, water is released in large quantities. Drying helps to prevent damage due to corrosion in compressed air systems and prevents malfunctions in the connected consuming devices.

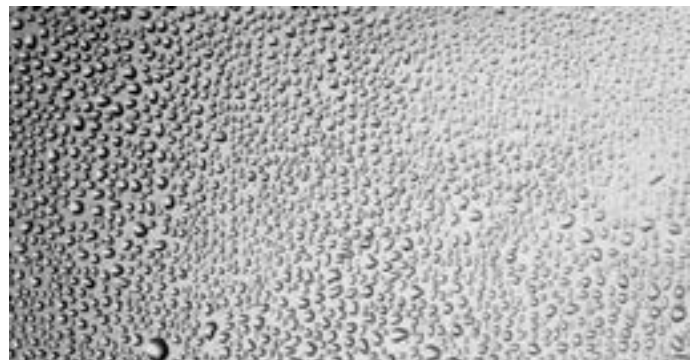

Compressed air preparation

Oil contamination

Similarly, in the case of compressors that operate without oil, oil aerosols present in the drawn-in air also lead to a residue of oil pollutants. However, this oil is not suitable for the lubrication of drives and can even lead to sensitive parts becoming blocked.

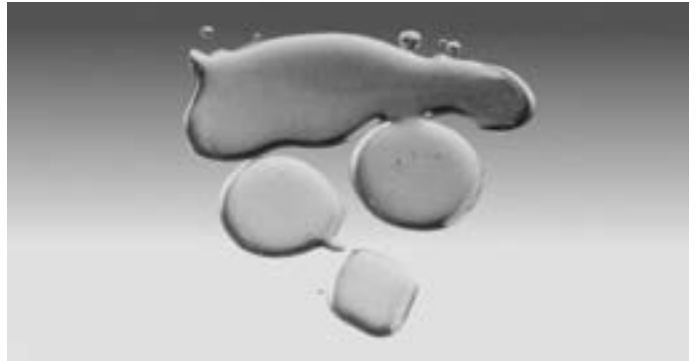

How clean should compressed air be?

The compressed air quality is determined by the requirements

The answer is quite simple: compressed air must be so clean that it cannot cause any malfunctions or damage.

As each filter also creates a flow resistance, for economic reasons compressed air should be only as clean as necessary.

The wide application range of compressed air places many different requirements on compressed air quality. If high quality air is required, several filtration stages are necessary → page 9. If just a single "fine" filter were used, it would quickly become ineffective.

Sizing

Note

Equipment at an air branching/air distribution input should have a high flow rate as it must meet the total air supply requirement.

Further information

→ www.festo.com/catalogue/air_preparation

The size of the service unit depends on the system's air consumption. Undersizing leads to pressure fluctuations and to reduced filter service life.

For cost reasons, high quality compressed air should only be used where it is absolutely necessary. Branching modules between the individual filter stages enable the user to tap off compressed air of various qualities.

Service unit functions

Compressed air filters remove particles and moisture droplets from the air. Particles > 40 ... 5 µm (depending on the grade of filtration) are retained by a sintered filter. Liquids are separated with the aid of centrifugal force. The condensate which accumulates in the filter bowl must be emptied from time to time, because it would otherwise be drawn in by the air flow.

Various industries often require finely filtered air. Fine and micro filters are used for this. Fine filters are used for prefiltering down to a particle size of 1 µm.

Micro filters further purify pilot air, removing practically all remaining water and oil droplets and contamination particles. The degree of compressed air filtration is 99.999% relative to a particle size of 0.01 µm.

The pressure regulator maintains a constant working pressure (secondary side), regardless of the pressure variations in the system (primary side) and the air consumption. Inlet pressure must always be greater than working pressure.

The compressed air lubricator provides pneumatic components with adequate lubricant if required. Oil is drawn from a reservoir and atomised when it comes into contact with the air stream. The lubricator is only functional when the air flow is sufficiently strong.

Compressed air preparation

Lubricated compressed air

The following notes must be observed when lubricated compressed air is used:

- Use Festo special oil OFSW-32 or the alternatives listed in the Festo catalogue (as specified in DIN 51524-HLP 32, viscosity 32 cSt at 40°C).
- If lubricated compressed air is used, additional lubrication must not exceed 25 mg/m³ (ISO 8573-1:2010). The quality of compressed air downstream of the compressor must correspond to that of unlubricated compressed air.
- The lifetime lubrication required for unlubricated operation can be "flushed out" when products are operated using lubricated compressed air. This can result in malfunctions if a system is switched back to unlubricated operation after lubricated operation.
- The lubricators should, where possible, always be installed directly upstream of the cylinders requiring lubrication in order to prevent operating the entire system with lubricated air.
- Never over-lubricate the system! To determine the correct lubricator settings, the following "oil form test" can be implemented: hold a piece of white card approx. 10 cm away from the exhaust port (without silencer) of a working valve of the cylinder furthest away. Allow the system to work for some time; the card

should only show a pale yellow colouration. If oil droplets appear, this is an indication that too much oil has been used.

- The colour and condition of the exhaust silencer provide further evidence of over-lubrication. Marked yellow coloration and dripping oil indicate that the lubrication setting is too high.
- Dirty or incorrectly lubricated compressed air will reduce the service life of the pneumatic components.
- Service units must be inspected at least twice a week for condensate and correct lubrication settings. These inspections should be included in the machine maintenance plan.
- To protect the environment, as little lubrication as possible should be used. Festo pneumatic valves and cylinders have been designed in such a manner that, under permitted operating conditions, additional lubrication is not required and yet a long service life is guaranteed.

Oil content

A differentiation must be made between residual oil for operation with unlubricated air and additional oil for operation with lubricated air.

Unlubricated operation:

Examinations involving residual oil content have revealed that the various types of oil have entirely different effects. A distinction must therefore be made between the following oil types when analysing the residual oil content:

- Bio-oils: oils based on synthetic or natural ester (e.g. rapeseed oil methyl ester). In this case, residual oil content must not exceed 0.1 mg/m³.

This corresponds to ISO 8573-1:2010 class 2

→ www.festo.com/catalogue/air/preparation.

Larger amounts of oil result in damage to O-rings, seals and other component parts (e.g. filter bowls) of devices in pneumatic systems, and may result in premature product failure.

- Mineral oils (e.g. HLP oils to DIN 51524, part 2) or similar oils based on polyalphaolefins (PAO). In this case, residual oil content must not exceed

5 mg/m³. This corresponds to ISO 8573-1:2010 class 4 → www.festo.com/catalogue/air/preparation.

A higher residual oil content is not permitted, regardless of the compressor oil, because permanent lubrication would otherwise be flushed out over a period of time. This can lead to malfunctions.

Humidity

Max. pressure dew point 3°C.

Corresponds to ISO 8573-1:2010, at least class 4

→ www.festo.com/catalogue/air/preparation.



Note

The pressure dew point must be at least 10 K lower than the temperature of the medium, since ice would otherwise form in the expanded compressed air.

Suitable oils

Special oil in 1 litre containers:

Order code: OFSW-32

Solid particles

Permissible particle load max. 10 mg/m³, particle size max. 40 µm.

Corresponds to ISO 8573-1:2010, class 7

→ www.festo.com/catalogue/air/preparation.



Note

Optimum compressed air preparation means fewer machine failures and greater process reliability. See

Air quality analysis → www.festo.com

Compressed air preparation

Purity classes for particles to ISO 8573-1:2010

Class	Maximum number of particles per m ³ as a function of particle size d		
	0.1 μm < d ≤ 0.5 μm	0.5 μm < d ≤ 1.0 μm	1.0 μm < d ≤ 5.0 μm
0	As stipulated by the user or supplier of the equipment, stricter requirements than class 1		
1	≤ 20000	≤ 400	≤ 10
2	≤ 400000	≤ 6000	≤ 100
3	Not specified	≤ 90000	≤ 1000
4	Not specified	Not specified	≤ 10000
5	Not specified	Not specified	≤ 100000
<hr/>			
Class	Mass concentration C _p		
	[mg/m ³]		
6 ¹⁾	0 < C _p ≤ 5		
7 ¹⁾	5 < C _p ≤ 10		
X	C _p > 10		

- 1) Air cleaned using universal filters designed for particle sizes of 5 μm (class 6) and 40 μm (class 7) is normally used for the compressed air supply to industrial tools and pneumatic machines. These designs have been used for many years, before the latest systems for measuring particle sizes were developed, and have enabled satisfactory operation while minimising pressure (and therefore performance) losses. These filters are not 100% efficient; they offer an efficiency of at least 95% based on the specified particle size, i.e. for class 6, 95% of all particles of size 5 μm are filtered; for class 7, 95% of all particles of size 40 μm are filtered (measured as per ISO 12500-3).

Purity classes for humidity and liquid water to ISO 8573-1:2010

Class	Pressure dew point
	[°C]
0	As stipulated by the user or supplier of the equipment, stricter requirements than class 1
1	≤ -70
2	≤ -40
3	≤ -20
4	≤ +3
5	≤ +7
6	≤ +10
<hr/>	
Class	Concentration of liquid water C _w
	[g/m ³]
7	C _w ≤ 0.5
8	0.5 < C _w ≤ 5
9	5 < C _w ≤ 10
X	C _w > 10

Purity classes for total oil content to ISO 8573-1:2010

Class	Total concentration of oil (liquid, aerosol and vapour)
	[mg/m ³]
0	As stipulated by the user or supplier of the equipment, stricter requirements than class 1
1	≤ 0.01
2	≤ 0.1
3	≤ 1
4	≤ 5
X	> 5

Compressed air preparation

Compressed air quality in use

Designation to ISO 8573-1:2010 [Particles:Water:Oil]

The class that can be achieved with compressed air preparation depends on the quality of the compressed air downstream of the compressor. The specifications apply to typical compressed air systems (this list is not exhaustive).

Central air preparation		Air distribution	Decentralised air preparation		Typical applications
Component	Class	Class	Component	Class ³⁾	
Compressor	[-:--]	[-:--]	Water separator	[-:7:4]	All applications requiring virtually condensate-free compressed air. No specific particle filtering.
Compressor + pre-filter + air dryer	[7:4:4] ¹⁾	[-:4:-] ²⁾	Filters 40 µm	[7:4:4]	Operating medium for valves, cylinders, secondary packaging (standard)
			Filters 5 µm	[6:4:4]	Servo-pneumatic positioning with proportional directional control valves, compressed air tools
			Filters 5 + 1 µm	[5:4:3]	Applications with a residual oil content < 0.5 mg/m ³ , textile industry, pneumatic spinning machines, paper industry
			Filters 5 + 1 + 0.01 µm	[1:4:2]	Applications with a residual oil content < 0.01 mg/m ³ , e.g. air bearings, varnishing, powder coating
			Filters 5 + 1 + 0.01 µm + activated carbon filter	[1:4:1]	Applications with a residual oil content < 0.003 mg/m ³ , reduction of oil vapours and odours, optical instruments, sealing air for precision glass scales/lasers, primary packaging
			Filters 5 + 1 + 0.01 µm + activated carbon filter + membrane air dryer	[1:3:1]	Semiconductor industry, pharmaceutical products
			Filters 5 + 1 µm + adsorption dryer	[2:2:2]	Applications in the low-temperature range, dry process air, powder transportation, food production [1:2:1]

1) Much higher classes are possible with suitable air preparation downstream of the compressor.

2) Pipe systems can increase the particle content of the compressed air (chips, rust, etc.), liquid oil can concentrate in some sections of the compressed air distribution. Specifications apply at normal room temperature. If parts in the compressed air system are subject to lower temperatures, the humidity class must be chosen so that the pressure dew point is 10 K below the minimum expected temperature.

3) Class to ISO 8573-1:2010 at room temperature 20°C

Definition of the compressed air purity class to ISO 8573-1:2010

The quality of the compressed air is determined by

- solid contaminants (particles),
- humidity and water, and
- oil content

The air purity class is specified as follows:

- A = Particles
- B = Humidity
- C = Oil content

Example:

ISO 8573-1:2010 [-:7:-]
 Particles: not defined
 Humidity: ≤ 0.5 g/m³
 Oil content: not defined

Operating conditions for valves

Compressed air quality

Under normal working conditions, pneumatic valves from Festo can be operated with lubricated or unlubricated compressed air.

If any particular product requires a different quality of compressed air, this is indicated in the technical data for the relevant product.

Operation with unlubricated compressed air is made possible by the selection of the material combination, the shape of the dynamic seals and the basic lubrication applied ex works.

Operation with unlubricated compressed air is not possible under the following working conditions:

- Once the valves have been operated with lubricated compressed air, it is essential that lubricated compressed air is always used subsequently since the oil in the lubricated air will have flushed away the basic lubrication.
- In all cases, a degree of filtration is required that removes contaminants up to 40 µm (standard filter cartridge version).

Microfiltration of compressed air may be required for special applications.

Nominal size

The nominal width provides information about the smallest cross section in the main flow of the valve. It specifies the diameter of the orifice and is expressed in mm.

This is a measurement that only provides a limited comparison between different components. To compare products, the standard nominal flow rate must also be considered.

Standard nominal flow rate

The standard nominal flow rate q_n is the flow rate characteristic used by Festo for a device or component expressed in l/min.

The standard nominal flow rate q_n is the flow rate based on standard conditions (to DIN 1343) under the following measurement conditions:

- Test medium air
- Temperature 20 ±3°C (temperature of medium)
- Test specimen at ambient temperature
- The pressures to be set are for components with constant cross section (e.g. directional control valves):
 - Input pressure $p_1 = 6$ bar
 - Output pressure $p_2 = 5$ bar

Standard conditions to DIN 1343:

- $t_n = 0^\circ\text{C}$ (standard temperature)
- $p_n = 1.013$ bar (standard pressure)

Exception 1:

Silencer

Input pressure $p_1 = 6$ bar

Output pressure $p_2 = p_{\text{amb}}$

$p_{\text{amb}} =$ atmospheric pressure

Exception 2:

Low-pressure components

Input pressure $p_1 = 0.1$ bar

Output pressure $p_2 = p_{\text{amb}}$

Exception 3:

For pressure regulators:

Input pressure $p_1 = 10$ bar (constant) and output pressure $p_2 = 6$ bar

at $q = 0$ l/min are set for the test specimen. Subsequently, the flow rate is slowly and constantly increased using the throttle valve until the output pressure reaches a value of $p_2 = 5$ bar. The resulting flow rate is measured.

Operating conditions for valves

Pressure and pressure ranges

Pressure

Force per area. There is a difference between differential pressure with respect to atmosphere and absolute pressure. Pressure specifications for pneumatic devices must normally be assumed to be differential pressure with respect to atmosphere, unless expressly indicated otherwise.

Symbol:

- Differential pressure with respect to atmosphere p
- Absolute pressure p_{abs}

Unit:

- bar
- MPa
- psi

1 bar = 0.1 MPa = 14.5 psi

Operating pressure

Data quoted as "max." or "max. permissible" values refer to the maximum safe pressure at which a component or system can be operated.

Operating pressure range

The range between the lowest required and highest permissible operating pressure for safe operation of a component or system. In pneumatics, this pressure range is also referred to as the operating pressure range.

Pilot pressure range

The range between the lowest required and highest permissible pilot pressure for correct operation of a valve or system.

The following pressures have been standardised to ISO 4399, for example: 2.5; 6.3; 10; 16; 40 and 100 bar.

Drop-off pressure

Pressure which, if no longer maintained, causes a monostable directional control valve to return to the normal position by its spring.

Absolute pressure

Zero pressure occurs in a completely air-free space (100% vacuum). Pressure that is calculated from this theoretical zero point is absolute pressure.

Response pressure

Pressure at which a directional control valve is actuated. Catalogue specifications for response pressure signify that the indicated minimum pressure must be present at the signal input to safely switch the valve.

Port identifications of pneumatic components to ISO 5599

Port designations	Using ISO 5599 numbers (5/2- and 5/3-way valves)	Using letters ¹⁾
Compressed air supply port	1	P
Working ports	2	B
	4	A
		C
Exhaust ports	3	S
	5	R
		T
Pilot ports (signal)	10 ²⁾	Z ²⁾
	12	Y
	14	Z
Pilot air ports (power supply)	81 (12)	
	81 (14)	
Pilot exhaust ports	83 (82)	
	83 (84)	
Leakage lines		L

- 1) Still frequently used
- 2) Clears the output signal

Operating conditions for drives

Compressed air quality

Under normal working conditions, pneumatic drives from Festo can be operated with lubricated or unlubricated dried compressed air. If any particular product requires a different quality of compressed air, this is indicated in the technical data for the relevant product. Operation with unlubricated compressed air is made possible by the choice of materials used, the material combinations, the shape of the dynamic seals and the basic lubrication applied ex works.

Operation with unlubricated compressed air is not possible under the following working conditions:

Once the drives have been operated with lubricated compressed air, it is essential that lubricated compressed air is always used subsequently since the oil in the lubricated air will have flushed away the basic lubrication.

Ambient conditions

Take the ambient conditions at the place of use into consideration. Corrosive, abrasive and dusty environments (e.g. water, ozone, grinding dust) will reduce the service life of the product.

Check the resistance of the materials of Festo products to the media used and surrounding media → page 23.

Intended use

Pneumatic drives are intended to convert pressure energy into motion energy; this process involves the transmission and transfer of forces. "Intended use" does not include use as a spring or cushioning component, since this would involve additional loads.

Frequency

If pneumatic drives are operated at maximum possible speed, a pause time must be taken into account between the stroke movements.

Mounting position

In general, drives from Festo can be installed in any position. Any limitations or special measures are indicated in the technical data for the relevant product.

Operating pressure

Data quoted as "max." or "max. permissible" values refer to the maximum safe pressure at which a drive or system can be operated.

Operating pressure range

The range between the lowest required and highest permissible operating pressure for safe operation of a component or system. In pneumatics, this pressure range is also referred to as the operating pressure range.

Effective force with single-acting cylinders

Permissible deviation of spring forces in accordance with DIN 2095, quality class 2, must be taken into consideration for the cylinders' effective force. The effective force is also reduced by the value of the frictional forces.

The degree of friction depends on the mounting position and the type of load involved. Lateral forces increase friction.

Frictional force must be lower than the spring return force. In as far as this is possible, single-acting cylinders should be operated without lateral forces.

Operating conditions for drives

Permissible stroke deviations for standard cylinders

ISO 15552 (corresponds to the withdrawn standards ISO 6431, DIN ISO6431, VDMA 24562, NFE 49003.1, UNI 10290), ISO 6432 and ISO 21287 permit a certain amount of stroke length deviation from the nominal value due to manufacturing tolerances. These tolerances are always positive. Refer to the table for details regarding precise permissible deviations.

Standard	Piston \varnothing [mm]	Stroke length [mm]	Permissible stroke deviation [mm]
ISO 6432	8, 10, 12, 16, 20, 25	0 ... 500	+1.5
ISO 15552	32	0 ... 500	+2
	40, 50	500 ... 12500	+3.2
	63	0 ... 500	+2
	80, 100	500 ... 12500	+4
	125, 160	0 ... 500	+4
ISO 21287	20, 25	0 ... 500	+1.5
	32, 40, 50	0 ... 500	+2
	63, 80, 100	0 ... 500	+2.5



Note

In the case of stroke lengths larger than those shown in the table, the tolerances must be agreed upon between the manufacturer and the user.

Contactless position sensing

Pneumatic drives from Festo with contactless position sensing are fitted with a permanent magnet on the cylinder piston, the magnetic field of which is used to actuate proximity switches. Proximity switches can be used to detect end or intermediate positions of cylinders. One or more proximity switches can be clamped on a cylinder, either directly or using mounting kits.



Piston diameter



This symbol is used to indicate piston diameter. Piston diameter is represented simply by \varnothing in size tables.

Pressure/force table

Piston force [N] ∅	Operating pressure [bar]							
	1	2	3	4	5	6	7	8
2.5	0.4	0.9	1.3	1.8	2.2	2.7	3.1	3.5
3.5	0.9	1.7	3.8	3.5	4.3	5.2	6.1	6.9
5.35	2	4	6.1	8.1	10.1	12.1	14.2	16.2
6	2.5	5.1	7.6	10.2	12.7	15.3	17.8	20.4
8	4.5	9	13.6	18.1	22.6	27.1	31.7	36.2
10	7.1	14.1	21.2	28.3	35.3	42.4	49.5	56.5
12	10.2	20.4	30.5	40.7	50.9	61.0	71.3	81.4
16	18.1	36.5	54.3	72.4	90.5	109	127	145
20	28.3	56.5	84.8	113	141	170	198	226
25	44.2	88.4	133	177	221	265	309	353
32	72.4	145	217	290	362	434	507	579
40	113	226	339	452	565	679	792	905
50	177	353	530	707	884	1060	1240	1410
63	281	561	842	1120	1400	1680	1960	2240
80	452	905	1360	1810	2260	2710	3170	3620
100	707	1410	2120	2830	3530	4240	4950	5650
125	1100	2210	3310	4420	5520	6630	7730	8840
160	1810	3620	5430	7240	9050	10900	12700	14500
200	2830	5650	8480	11300	14100	17000	19800	22600
250	4420	8840	13300	17700	22100	26500	30900	35300
320	7240	14500	21700	29000	36200	43400	50700	57900

Piston force [N] ∅	Operating pressure [bar]						
	9	10	11	12	13	14	15
2.5	4	4.4	4.9	5.3	5.7	6.2	6.6
3.5	7.8	8.7	9.5	10.4	11.3	12.1	13
5.35	18.2	20.2	22.2	24.3	26.3	28.3	30.3
6	22.9	25.4	28	30.5	33.1	35.6	38.2
8	40.7	45.2	49.8	54.3	58.8	63.3	67.9
10	63.6	70.7	77.8	84.8	91.9	99	106
12	91.6	101	112	122	132	143	153
16	163	181	199	217	235	253	271
20	254	283	311	339	368	396	424
25	398	442	486	530	574	619	663
32	651	724	796	869	941	1010	1090
40	1020	1130	1240	1360	1470	1580	1700
50	1590	1770	1940	2120	2300	2470	2650
63	2520	2810	3090	3370	3650	3930	4210
80	4070	4520	4980	5430	5880	6330	6790
100	6360	7070	7780	8480	9190	9900	10600
125	9940	11000	12100	13300	14400	15500	16600
160	16300	18100	19900	21700	23500	25300	27100
200	25400	28300	31100	33900	36800	39600	42400
250	39800	44200	48600	53000	57400	61900	66300
320	65100	72400	79600	86900	94100	101000	109000

The piston force F can be calculated from the piston area A , the operating pressure p and the friction R using the following formulae:

$$F = p \cdot A - R$$

$$F = p \cdot 10 \cdot \frac{d^2 \cdot \pi}{4} - R$$

p = Operating pressure [bar]

d = Piston diameter [cm]

R = Friction ~10% [N]

A = Piston surface [cm²]

F = Effective piston force [N]

ProPneu software tool for sizing can be found on the DVD and at www.festo.com

Pressure/force graph

Operating pressure p as a function of piston diameter and force F

An allowance of 10% has been included for frictional force

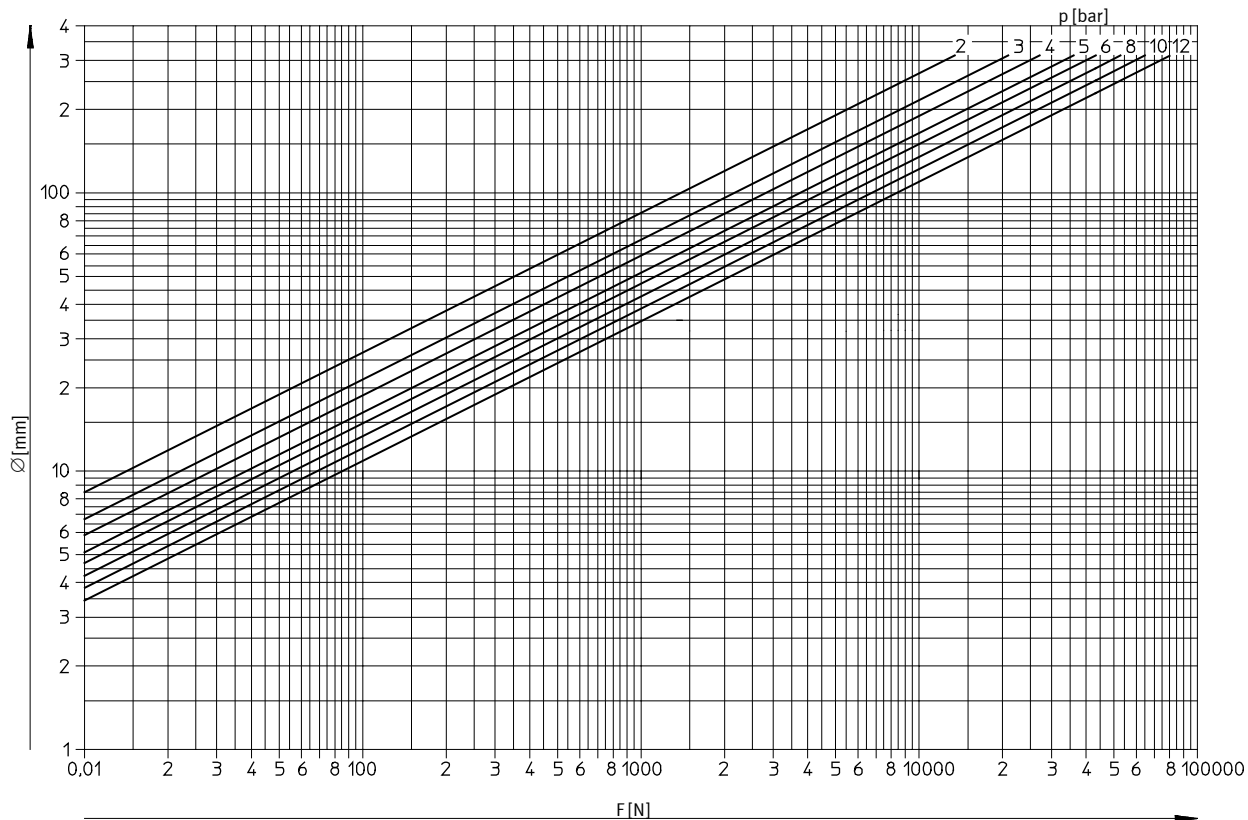

Assuming:

Load: 800 N

Available system pressure: 6 bar

To be determined:

Required piston diameter

Operating pressure to be set

Procedure:

From $F = 800$ N go straight up to where it intersects the 6 bar line. The next largest piston diameter, 50 mm, lies between the lines for 4 and 5 bar, which means that the operating pressure should be set to approx. 4.5 bar.

The selection of pneumatic drives is determined primarily by the forces to be overcome and the distances to be travelled. A small percentage of the piston force is used to overcome friction, the remainder is used to drive the load.

Only approximate values can be given, since friction force depends on numerous factors (lubrication, operating pressure, back pressure, seal design, etc.). Back pressure generates a force which acts in the opposite direction and partially cancels out the effective force. Back pressure occurs in particular when exhaust air flow controls are used or the exhaust port is constricted.

Buckling load graph

Piston rod diameter as a function of stroke length l and force F

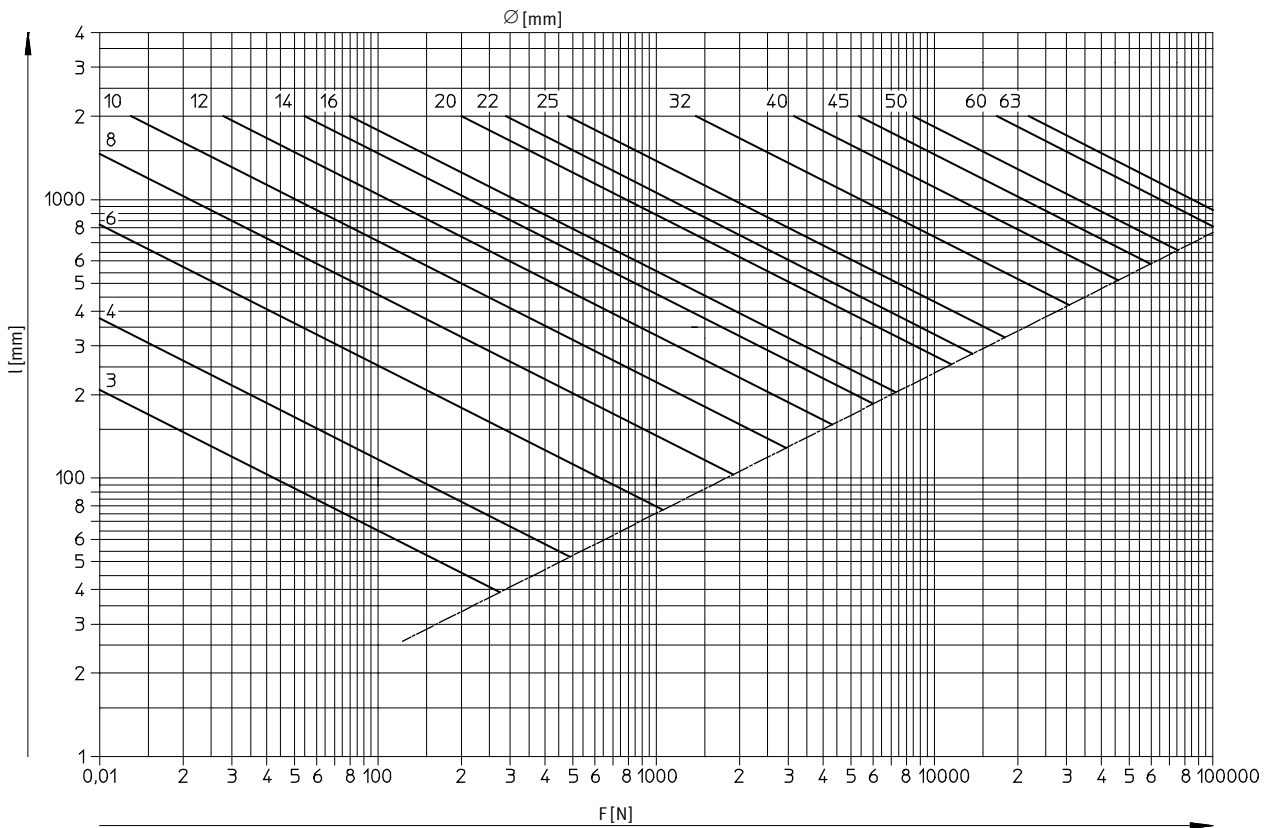

Assuming:

Load: 800 N

Stroke length: 500 mm

Piston \varnothing : 50 mm

To be determined:

Piston rod diameter

Cylinder type: Standards-based cylinder

Procedure:

From $F = 800$ N go straight up to where it intersects the horizontal line through $l = 500$ mm. The next largest piston rod diameter in the graph is 16 mm. The standards-based cylinder DNC-50-500 with a piston rod diameter of 20 mm is suitable for this stroke length.

Due to buckling stress, the maximum permissible load for a piston rod with a long stroke length is lower than the value suggested by the maximum permissible operating pressure and piston area. This load must not exceed certain maximum values. These depend on stroke length and piston rod diameter.

The graph shows this relationship based on the following formula:

$$F_K = \frac{\pi^2 \cdot E \cdot J}{l^2 \cdot S}$$

F_K = Permissible buckling force [N]

E = Modulus of elasticity [N/mm²]

J = Moment of inertia [cm⁴]

l = Buckling length

= 2x stroke length [cm]

S = Safety factor (selected value: 5)

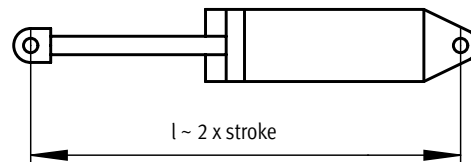

Note

The least satisfactory type of mounting for this kind of stress is a swivel mounting. The permissible load is higher for other types of mounting.

Air consumption

Air Consumption sizing software

The sizing software "Air Consumption" determines the air consumption of a cylinder (approximate value), taking into consideration the following parameters:

This tool can be found online under Support in the engineering software area.

- Mode of operation of the cylinder
- Piston diameter
- Number of cycles
- Stroke length
- Operating pressure

Calculating air consumption using the engineering software

Assuming:

Cylinder: DNC-32-500
 Piston diameter: 32 mm
 Piston rod diameter: 12 mm
 Stroke length: 500 mm
 Operating pressure: 6 bar
 Number of cycles per minute: 60 1/min

To be determined:

Air consumption

Results:

Once the parameters have been entered, the following values are returned for the air consumption:

Per cycle: 5.23 l

Per minute: 314.03 l

Cylinder Air Consumption



Calculating air consumption using the formula

$$Q = \frac{\pi}{4} \cdot (d1^2 - d2^2) \cdot h \cdot (p + 1) \cdot 10^{-6}$$

Q = Air consumption [l] per cm stroke

d1 = Piston diameter [mm]

d2 = Rod diameter [mm]

h = Stroke [mm]

p = Operating pressure, relative [bar]

Forward stroke:

$$Q = \frac{\pi}{4} \cdot (32\text{mm})^2 \cdot 500\text{mm} \cdot (6\text{bar} + 1\text{bar}) \cdot 10^{-6}$$

$$Q = 2.815 \text{ l}$$

Return stroke:

$$Q = \frac{\pi}{4} \cdot ((32\text{mm})^2 - (12\text{mm})^2) \cdot 500\text{mm} \cdot (6\text{bar} + 1\text{bar}) \cdot 10^{-6}$$

$$Q = 2.419 \text{ l}$$

Air consumption per cycle:

$$Q = 2.815 \text{ l} + 2.419 \text{ l} = 5.234 \text{ l}$$

Pneumatics and explosion protection – ATEX

What does ATEX mean?

Explosive atmospheres are a constant hazard in the chemical and petrochemical industries because of the processing techniques used. These explosive atmospheres are caused by escaping gas, vapours and mist, for example. Explosive atmospheres can also occur in mills, silos and sugar and feed processing plants because of the dust/oxygen mixtures there.

Electrical equipment in potentially explosive areas is therefore subject to a special directive, 2014/34/EU. This directive was also extended to non-electrical equipment on 1 July 2003.

ATEX - Directive 2014/34/EU



ATEX is an acronym of the French expression "Atmosphère explosible".

- **Directive 2014/34/EU** stipulates the minimum safety requirements for equipment and protective systems that are to be operated in explosive atmospheres and that have their own ignition sources.

- It applies to the sale of equipment and protective systems within the European Economic Area.
- It relates to both electrical and non-electrical devices, if they have their own potential ignition source.

Dual responsibility

When equipment for explosion protection areas is being produced, system manufacturers and component suppliers must work closely together to ensure that the correct category and explosion protection zone are chosen.

Explosion protection documentation from system manufacturer	Festo/equipment supplier
System rating Directive 1999/92/EC	Equipment rating Directive 2014/34/EU
	
Results: <ul style="list-style-type: none"> • Zone classification • Temperature classes • Explosion groups • Ambient temperature 	Results: <ul style="list-style-type: none"> • Equipment categories • Temperature classes • Explosion groups • Ambient temperature
Zone	Category

Explosion protection classes			Equipment group	Equipment category	Area of application
Zone Gas	Zone Dust	Frequency			
–	–	–	I	M M1 M2	Mining
			II	–	All non-mining areas of application
0	–	Constant, frequent, long-term	II	1G	Gas, mist, vapour
–	20		II	1D	Dust
1	–	Occasional	II	2G	Gas, mist, vapour
–	21		II	2D	Dust
2	–	Seldom, short-term in the event of a fault	II	3G	Gas, mist, vapour
–	22		II	3D	Dust

Pneumatics and explosion protection – ATEX

ATEX at Festo?

→ www.festo.com/atex

Products requiring approval

Products not requiring approval

Products requiring approval are those that have their own potential ignition risk. They are labelled with the CE marking and the explosion protection hexagon; operating instructions and the EU declaration of conformity are provided.

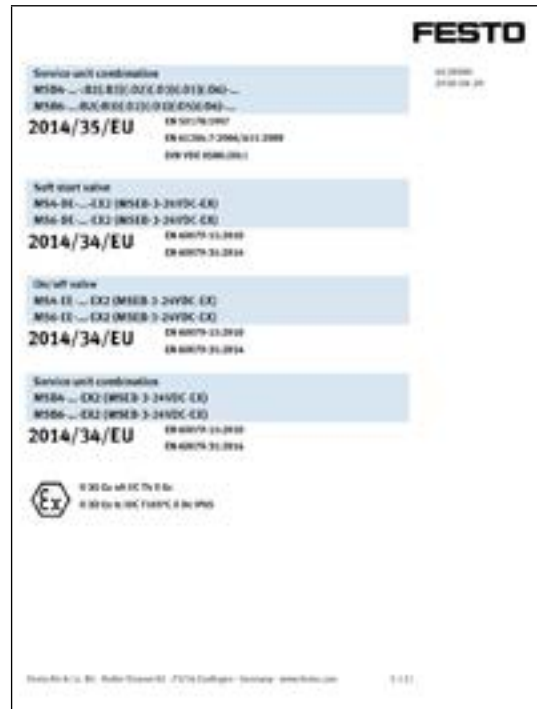

Products not requiring approval are those that do not have their own potential ignition source. These products can be used in specific explosion zones in compliance with our manufacturer's instructions:

- Pneumatic accessories
- Tubing
- Fittings
- Pneumatic sub-bases
- Flow control and shut-off valves
- Non-electrical service units
- Mechanical accessories.

Festo's product range for explosion protection includes products for equipment category II



According to Directive 2014/34/EU, both the solenoid coil and the working valve require approval. At Festo, each have a separate rating plate so that it is possible to tell at a glance where the valve may be used.

Important: The equipment with the lowest equipment category defines the category for the module.

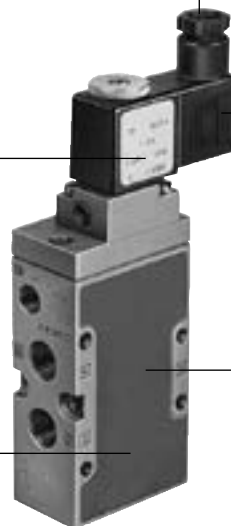

Plug = not requiring approval, must satisfy defined requirements

Solenoid coil = electrical equipment

Non-electrical part of the solenoid valve (power valve) must be approved

For the module in this example:
II 3G T4

Note
The permissible technical catalogue data for the equipment in question as well as the warning notices and safety information in the special documentation provided (including operating instructions or, if applicable, device documentation) must be observed.

EU or EC directives/certifications

EU or EC directives (CE marking)



Festo SE & Co. KG adheres in principle to the applicable regulations. All information is based on the current level of knowledge and is subject to change. We carefully follow any amendments/additions to these regulations and will produce our products accordingly.

This guarantees that products from Festo SE & Co. KG always comply with the currently valid requirements.

Most pneumatic products are not subject to any EC directive and are therefore not given a CE marking. Products from the sales range of Festo SE & Co. KG that are labelled with the CE marking are currently subject to one or more of the following six EU or EC directives in Europe.

1. EC Machinery Directive 2006/42/EC, including amendments: 2006/42/EC:2007-03-16 and 2009/127/EC:2009-10-21

Pneumatic products from Festo SE & Co. KG are designed in accordance with the standard for pneumatic systems ISO 4414 "Pneumatic fluid power – General rules and safety requirements for systems and their components". Our pneumatic products do not fall within the scope of application specified in the Machinery Directive.

They must therefore not be labelled with the CE marking in accordance with the Machinery Directive. Exceptions to this are safety devices. As of 29 December 2009, incomplete machines also fall under the scope of the Machinery Directive. This includes handling systems designed for installation in machines, for example. Incomplete machines are not labelled with the CE marking. A declaration of incorporation is enclosed with the machines instead of a declaration of conformity.

2. EU Electromagnetic Compatibility Directive (2014/30/EU), including amendments.

The directive must be applied to our electronic and electronic/pneumatic products. The corresponding products have the CE marking and the corresponding declaration of conformity is available. For you, this means a guarantee that this equipment complies with the fundamental requirements in industrial areas. The use of this equipment in residential areas is restricted if no additional measures are taken to guarantee compliance with the fundamental requirements of the directive for residential areas!

Solenoid coils are not affected by the EMC Directive.

3. EU Low Voltage Directive (2014/35/EU), including amendments.

Electric and electronic products from Festo designated for use within specific voltage limits (50 ... 1000 V AC and 75 ... 1500 V DC) must be labelled with the CE marking. The corresponding declarations of conformity are available.

4. EU Directive on Simple Pressure Vessels (2014/29/EU), including amendments.

The simple pressure vessels made from non-alloyed steel offered by Festo SE & Co. KG comply with the requirements of this directive. These air reservoirs require CE marking above a certain volume.

These products are labelled with the CE marking. The declaration of conformity is available.

5. EU Directive on Pressure Equipment (2014/68/EU), including amendments.

The pressure equipment offered by Festo SE & Co. KG complies with the requirements of this directive. These pressure vessels require a CE marking above a certain pressure/volume or pressure/diameter.

These products are labelled with the CE marking. The declaration of conformity is available.

Stainless steel pressure vessels are subject to the Pressure Equipment Directive rather than the Simple Pressure Vessels Directive.

6. EU Directive on Equipment and Protective Systems for Use in Explosive Atmospheres - ATEX (2014/34/EU).

The products offered by Festo SE & Co. KG which are intended for use in potentially explosive atmospheres and which have their own potential ignition risk comply with the requirements of this directive. Products that are subject to this directive are correspondingly labelled with the CE marking and identified in compliance with the directive. The relevant declaration of conformity and the operating instructions are available.

Product markings		
	See above	
	To EU Directive 2014/34/EU (ATEX) Additional marking for equipment and protective systems for use in accordance with regulations in a potentially explosive atmosphere	
		UL certification for use in Canada and the USA. Recognized Product, intended for installation e.g. valve terminal MPA-S.
		UL certification for use in Canada and the USA. Listed Product, a ready-to-use device, for example limit switch with cable and plug.
		CSA certification for Canada and the USA.

Design – Cleanroom suitability

Design awards

Festo products appear regularly on the winners' podium in major design competitions. There is much more to good design than being "pleasing to the eye". The design emphasises and symbolises the cutting-edge technology and long-standing value of Festo products.



reddot

Cleanroom suitability

→ www.festo.com/de/cleanroom

Cost-effective series for cleanroom class 7

At Festo, cost-effective standard pneumatic components take the place of complex special designs because the quality concept applies to virtually all series-produced products. They are suitable for use in a class 7 cleanroom to ISO 14644-1.

Close-to-standard products for cleanrooms to class 4

Stringent requirements but still an optimum cost/benefit ratio. At Festo, class 4 also means standard products – with just one restriction: they are not available ex-stock. However, they can be delivered to you at short notice.

Individuality made to measure

If you need to go as far as class 1, the products will be manufactured according to your specific requirements. Festo integrates these application-oriented solutions in close-to-standard production, which means they will be available the next time you need them.

The reliability to meet the highest requirements

Festo works with the Fraunhofer Institute for Production Technology and Automation (IPA) and the renowned Nanyang Technological University in Singapore to ensure that its products meet the high requirements for use in cleanrooms. A dedicated Competence Centre for Cleanroom Technology at Festo Singapore offers the necessary infrastructure for the production of pneumatic cleanroom products.

Paint-wetting impairment substances and media resistance

Products free of paint-wetting impairment substances

	PW	B	S
Paint-wetting			
impairment			
substances			

Paint-wetting impairment substances cause small concave indentations at various points in the paint layer when surfaces are painted.

Silicone, fluoric materials, certain oils and greases may contain substances of this kind.

Components used in the automotive industry, and especially in painting systems, must be free of paint-wetting impairment substances.

Because it is impossible to determine the level of paint-wetting impairment substances contained in substances and components with the naked eye, Volkswagen developed the test standard PV 3.10.7.

All products from Festo and the lubricants used in them undergo this test. Products from Festo are free of paint-wetting impairment substances as standard. However, grease containing paint-wetting impairment substances needs to be used for some products for functional and other reasons.

The following are free of paint-wetting impairment substances

- Individual parts and modules that are manufactured without using materials, consumables or sundries containing paint-wetting impairment substances. Tests carried out during the sampling procedure as well as random sample tests of incoming goods through extraction must not cause any paint-wetting impairment effects.
- Liquid or paste-like sundry materials (e.g. lubricating greases) that do not cause any paint-wetting impairment effects through application as a result of the test.
- Products that consist of PWIS-free parts and contain PWIS-free lubricants.

Media resistance database

→ www.festo.com/media_resistance

It is well known that the resistance of materials depends on many parameters such as concentration of contact medium, temperature, pressure, duration of contact, stroke speed and switching frequency, quality of the surface in the case of mating frictional parts, flow velocity and stress as well as ageing.

This applies in particular to the compatibility of elastomers with special chemical compounds.

The Festo resistance database shows you the suitable material and its resistance to chemical substances.

The information contained in this database is based on lab tests from raw material manufacturers, material tables from semi-finished product and seal suppliers and practical experience.

The information is evaluated and the tables are created based on the knowledge available. Although every effort has been made to ensure the accuracy of this database, its contents should only be used for reference purposes.

Please note that the recommendations in this resistance database can neither be guaranteed nor serve as the basis for a warranty claim.

Wherever possible and especially in cases of doubt, it is advisable to perform a practical test with the desired product under actual working conditions.

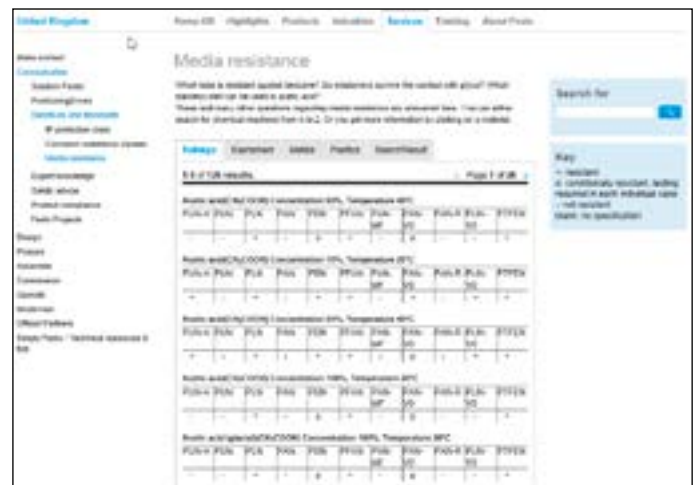

Corrosion resistance class CRC

Corrosion resistance class CRC to Festo standard FN 940070		
CBC	Corrosion resistance	Description
0	No corrosion stress	Applies to small, visually unimportant standards-based parts such as threaded pins, circlips and clamping sleeves that are usually only available on the market in a phosphated or burnished version (and possibly oiled) as well as to ball bearings (for components < CRC 3) and plain bearings.
1	Low corrosion stress	Dry internal application or transport and storage protection. Also applies to parts behind covers, in the non-visible interior area, or parts that are covered in the application (e.g. drive trunnions).
2	Moderate corrosion stress	Indoor applications in which condensation can occur. External visible parts with primarily decorative surface requirements that are in direct contact with a normal industrial environment.
3	High corrosion stress	Outdoor exposure under moderate corrosive conditions. External visible parts with primarily functional surface requirements that are in direct contact with a normal industrial environment.
4	Very high corrosion stress	Outdoor exposure under extreme corrosive conditions. Parts exposed to aggressive media, e.g. in the chemical or food industries. Such applications may need to be safeguarded by special tests (→ also FN 940082), using appropriate media.

Protection classes to IEC/EN 60529

Protection of electrical equipment

The term "IP" (International Protection) is defined by IEC/EN 60529 "Degree of Protection Provided by Enclosures (IP Code)" and DIN 40050 "IP Protection Classes" (standard for electrical equipment in road vehicles). These standards describe the classification of the protection classes provided by enclosures for electrical equipment with rated voltages of up to and including 72.5 kV. They set forth the following:

- Protection of individuals against contact with live or moving components within enclosures (protection against accidental contact).

- Protection of equipment inside the housing against ingress of solid foreign matter, including dust (foreign matter protection).
- Protection of electrical equipment against damage that would result if water were to enter the enclosure (protection against water).

The IP code to IEC/EN 60529

The degree of protection provided by an enclosure is established using standardised testing methods. The IP code is used for classifying this degree of protection.

The IP code is made up of the letters IP and a two-digit code number. The definition of the two digits is explained in the table below → page 26.

Meaning of digit 1:

Digit 1 denotes firstly the protection of individuals. It specifies the extent to which the enclosure prevents individuals from coming into contact with dangerous parts. The enclosure prevents or restricts the entry of body parts or of objects held by an individual. Secondly, digit 1 specifies the extent to which the equipment is protected against the ingress of solid foreign objects.

Meaning of digit 2:

Digit 2 refers to the protection of equipment. It rates the degree of protection of the enclosure with respect to the harmful effects on the equipment if water were to enter the enclosure.

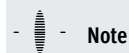

Note

The food industry generally uses components with degree of protection IP65 (dustproof and water-jet proof) or IP67 (dustproof and capable of brief submersion). The use of IP65 or IP67 depends on the specific application, as each is governed by completely different test criteria. IP67 is not necessarily better than IP65. A component that fulfils the IP67 criteria does not therefore automatically meet the criteria for IP65.

Protection classes to IEC/EN 60529

IP codes

IP 6 5

Code letters	
IP	International Protection

Digit 1	Brief description	Definition
0	Not protected	–
1	Protected against solid foreign objects, 50 mm and larger	A probing object, a ball of 50 mm in diameter, must not enter or penetrate the enclosure.
2	Protected against solid foreign objects, 12.5 mm and larger	A probing object, a ball of 12.5 mm in diameter, must not enter or penetrate the enclosure.
3	Protected against solid foreign objects, 2.5 mm and larger	A probing object, a ball of 2.5 mm in diameter, must not penetrate at all.
4	Protected against solid foreign objects, 1.0 mm and larger	A probing object, a ball of 1 mm in diameter, must not penetrate at all.
5	Protected against dust	The ingress of dust is not completely prevented. The amount of dust that enters must not impair the safety or satisfactory operation of the equipment.
6	Dustproof	No ingress of dust.

Digit 2	Brief description	Definition
0	Not protected	–
1	Protected against dripping water	Vertically falling droplets must not have any harmful effect.
2	Protected against dripping water	Vertically falling droplets must not have any harmful effect when the housing is at an angle of 15° either side of the vertical.
3	Protected against spraying water	Water sprayed at any angle of up to 60° either side of the vertical must not have any harmful effect.
4	Protected against splash-water	Water splashing against the housing from any angle must not have any harmful effect.
5	Protected against water jets	Water jets directed at the housing from any angle must not have any harmful effect.
6	Protected against powerful water jets	Powerful water jets directed at the housing from any angle must not have any harmful effect.
7	Protected against the effect of brief submersion in water	Water must not enter the equipment in amounts that can have a harmful effect if the housing is briefly submerged in water under standardised pressure and time conditions.
8	Protected against the effect of continuous submersion in water	Water must not enter the equipment in amounts that can have a harmful effect if the housing is continuously submerged in water. The conditions must be agreed on between the manufacturer and the user. The conditions must, however, be more stringent than code 7.
9K	Protected against water from high-pressure and steam jet cleaning	Water directed at the housing from any angle under high pressure must not have any harmful effect.

Functional earth – Protective earth – PELV

Concepts for ensuring protection against electric shock to IEC 60364-4-41/VDE 0100 Part 410

Definitions

Protection against electric shock means protection against indirect and direct contact.

Protection against direct contact implies that under normal operating conditions, live parts which are not insulated are protected against accidental contact.

Protection against indirect contact implies that in the event of an insulation fault between live parts and bodies or enclosures, contact voltages outside of the permissible range cannot occur or are disconnected promptly.

The three best-known and most widely used concepts for ensuring protection against electric shock are also referred to as protection class I to III in specialist literature and standardisation documentation.

Protection class I – Protective earth conductor

In the case of electrical equipment in protection class I, protection against direct contact is ensured by basic insulation.

Protection against indirect contact is provided by prompt disconnection of the fault voltage. This disconnection is ensured by the contact between the protective earth conductor and the equipment enclosure via protective earth.

If an insulation fault occurs in the equipment, the fault current flows via the protective circuit against the earth potential, thereby triggering the upstream fuse element (e.g. residual current device protection or circuit-breaker).

Equipment in protection class I includes lights, white goods (washing machines, dryers, etc.) and industrial machinery. Symbol:



Protection class II – Protective insulation

In the case of equipment in protection class II, the protection refers to direct and indirect contact with the improved enclosure insulation. The enclosure insulation is reinforced or doubled so that it is not possible to come into contact with contact voltages outside of the permissible range either in the event of a fault or during operation.

Equipment in protection class II must not be connected to the protective circuit. Therefore the equipment does not have a protective contact on the plug.

Equipment in protection class II includes hi-fi components, electric power tools and household appliances and is identified with the following symbol:

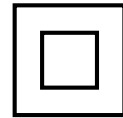

Protection class III – Protective extra-low voltage

In the case of equipment in protection class III, protection against direct and indirect contact is ensured both by a sufficiently high IP degree of protection (protection against direct contact with live parts) and by supplying the component with PELV (protective extra-low voltage) or SELV (safety extra-low voltage) (protection against indirect contact in the event of a fault).

Equipment in protection class III is frequently identified (no mandatory identification) with the following symbol:



Functional earth – Protective earth – PELV

Special protection measures for components from Festo

Protection class III

On the basis of the information currently available, all 24 V DC valve terminals (e.g. CPV, MPA), position controllers (e.g. SPC), sensors (proximity switches, pressure switches, pressure sensors) and proportional valves from Festo belong to protection class III.

This means that, in the case of the 24 V DC components from Festo, protection against direct and indirect contact is ensured by a sufficiently high IP degree of protection as well as by supplying the component with protective extra-low voltage – PELV.

The use of a PELV supply ensures that no contact voltages outside of the permissible range can occur in the event of a fault due to the high dielectric strength (4 kV) from the primary to the secondary side.

The earth terminal therefore is a functional earthing (discharge of electromagnetic disturbances) rather than a protective earth function and must always make contact.

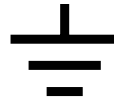

Why does Festo use protection class III?

Due to the increasingly compact designs of modern automation components, protection class I is no longer the optimum solution with respect to design size. This is because the standards specify minimum distances for the air and leakage paths, which means that further minimising the size of the components is no longer possible.

It is for this reason that protection class III (no protective earth conductor, as protection against electric shock is provided by protective extra-low voltage) is used in modern automation components.

What do customers need to know about installing equipment in protection class III?

The electrical supply to the equipment must be provided by PELV circuits to IEC/EN 60204-1 only. The general requirements for PELV circuits to IEC/EN 60204-1 must be taken into account. Power sources are permitted if reliable electrical isolation of the operating voltage to IEC/EN 60204-1 is guaranteed.

The earth terminals on the components, where available, are used for deflecting electromagnetic disturbances, equipotential bonding and thus ensuring proper functioning. They must be connected to the earth potential with low resistance (short cables with large cross section).

Spark arresting

Spark arresting of switch contacts in circuits with solenoid coils

The inductance of solenoid coils stores electromagnetic energy when the circuit is switched on and this is discharged when switched off. Depending on the switch used, this energy is either converted to a voltage peak (switch-off overvoltage), which can cause a breakdown in the insulation, or an arc which can burn away the

contacts (material creep). Various types of components can be used to avoid these effects by slowly and constantly discharging the electromagnetic energy.

Electronic arc arrestors

If the polarity in DC circuits is clearly defined, a simple diode can be used, wired parallel to the coil. It must be noted that this considerably increases the solenoid switch-off time.

A more suitable arrangement consists of two zener diodes, wired with opposing polarity parallel to the coil, which can be used for DC and AC. This prevents switch-off delays. However, several zener diodes must be wired in series for voltages over 150 V.

Varistors are ideal elements for attenuating the switch-off overvoltage, as their leakage current only begins to rise when the nominal voltage is exceeded. They are suitable for DC and AC.

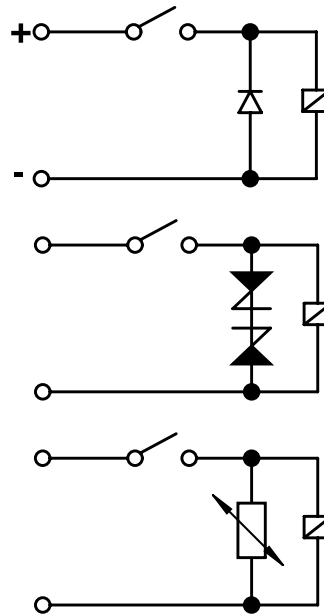

100% duty cycle

Within DIN VDE 0580, the 100% duty cycle test covers only the electrical part of the solenoid coil. Festo also includes the pneumatic part in this test.

The worst-case scenario is reviewed in the test. The test constitutes a functional test of the solenoid. If the solenoid is also used on valve terminals, the 100% duty cycle test is performed on the individual device and on equipment in a manifold assembly.

Conditions

- The solenoids are operated with the maximum permissible voltage (continuous operation S1 to DIN VDE 0580).
- The solenoids are subjected to the maximum permissible ambient temperature in a temperature cabinet (non-convecting).
- The solenoids are supplied with the maximum permissible operating pressure with sealed working ports.

Execution

The solenoids are operated for at least 72 hours under the above conditions. At the end of this period, the following tests are carried out:

- Drop-off current measurement: drop-off behaviour when de-energised.
- Starting behaviour when immediately energised with the minimum operating voltage and with the least favourable pressure ratios for excitation.
- Leakage measurements.
- Once the results have been recorded, this process is repeated again until the units being tested have reached a total duty cycle of at least 1000 hours or a termination criterion has been fulfilled.
- Following completion of the 100% duty cycle test, the sealing nipples are inspected visually for damage.

Termination criterion

The drop-off behaviour, starting behaviour or leakage exceeds or falls below the following limit values.

- Drop-off current: > 1.0 mA
- Starting voltage: > UN+10%
- Leakage: > 10 l/h